

# Hobby AIR BRUSH



**AB-101**



**AB-102**

**AB-101/AB-102**

**AIR BRUSH KIT(W/PROPEL)**

Plastic frame with precise siphoning nozzle and push-button control,  
Handy spray kit hobby, art work, etc.

Specification:

Working pressure :15-35PSI

Air consumption :0.6-1.0 CFM

Glass jar :1-22C.C. 1-50C.C

**AB-101**

20SETS/CTN/2.0' NW:10.4KGS GW:11.4KGS 10SET/BOX

**AB-102**

20SETS/CTN/2.2' NW:10.4KGS GW:11.4KGS



## AB-104 AIR BRUSH KIT

Economic design for air brush work. Siphoning nozzle and push-button control. Ideal for hobby art work.

Specification:

Working pressure :15-30PSI

Air consumption :0.6-1.0 CFM

Glass jar :22C.C.

80SETS/CTN/2.4' NW:12KGS GW:14KGS



## AB-104 AIR BRUSH KIT

Economic design for air brush work. Siphoning nozzle and push-button control. Ideal for hobby art work.

Specification:

Working pressure :15-30PSI

Air consumption :0.6-1.0 CFM

Glass jar :22C.C.

80SETS/CTN/2.4' NW:12KGS GW:14KGS

# ***Fine*** AIR BRUSH KIT

TAIWAN PAT. NO.50399

## **AB-105 AIR BRUSH KIT**

Double-action trigger Air-Paint control, Adaptor permits for using with propel can or air compressor, excellent for fine art work and hobby craft, etc.

Contents:

1-Air brush, 1-Adaptor, 1-22C.C. Cup, 1-Regulator,  
1-5' Air hose set, 1-wrench 1-Manual

Specification:

Fluid nozzle :0.3mm

Working pressure :15-30PSI

Air consumption : 0.4-0.8 CFM

Cup capacity : 22C.C.

Cup fix :Side screw fix

40SETS/CTN/1.9' NW:14.2KGS GW:15.2KGS



**FULL SET OF AB-105**



# ARTWORK KIT

The artwork kit develops itself as multi-functional, easy portable, and impact resistance blow case packing. The contents including necessary tools for artworking. All tools are in eye-shoting position, and make your work easy & convenient. It's most suitable for artwork, designs, models....



## AIR BRUSH ARTWORK KIT

### FULL SET OF ABI05-ABI19

Rulers.....	4PCS	Thumb tacks.....	20PCS
A pair of compasses.....	1PC	Oil plpe.....	1PC
Pencil cutter.....	1PC	Oil boxes.....	1PC
Pencil.....	1PC	Cleaners.....	2PCS
Tape adhere to cutter...1PC		Big glass jar, 50C.C.....	1PC
Plastic eraser.....	1PC	Small glass jar, 22C.C...1PC	
Art knife.....	1PC	Scissors.....	1PC
Brushes.....	1PC	Air brush.....	1SET

● This Picture is just for reference, the actual contents depends on the items.

10SETS/CTN/3.3'

## AB-106 KIT SPRAY GUN W/PROPEL CAN

### Contents:

- 1 x spray gun & power pack.
- 1 x plastic dip tube.
- 1 x glass jar & lid.
- 1 x instruction leaflet.

### Specification:

- Fluid nozzle :0.5mm
- Cup capacity :175C.C.

36SETS/CTN/2.4' NW:11.4KGS GW:12.1KGS



## AB-115 AIR BRUSH KIT

Double-action trigger Air-Paint control, precisely machined nozzle, Air and paint regulator assure fine spray pattern, Suitable for all brush work, graphic arts, etc.

Contents:

1-Air brush, 1-Adaptor, 1-22C.C. Cup, 1-Regulator,  
1-5' Air hose set, 1-wrench 1-Manual

Specification:

Fluid nozzle :0.3mm  
Working pressure :15-30PSI  
Air consumption : 0.4-0.8 CFM  
Cup capacity : 22C.C.  
Cup fix :Side screw fix

24SETS/CTN/1.0' NW:14.4KGS GW:15.1KGS



TAIWAN PAT. NO.26053

FULL SET OF AB-115

# UTILITY KIT

The utility kit develops itself as multi-functional, easy portable, deluxe, practical essence and innovative outer blow case packing. Owing to its well-prepared contents, you can fully employ its functions in the most convenient way and after use, it's easier to be cleaned & packed up in the promptest & time-saving way for you to maintain and reserve. It's most suitable for professional experts on arts, designs, models.....



## AIR BRUSH UTILITY KIT

### FULL SET OF AB115-AB129

Brush.....	1PC	Cleaner.....	1PC
Holder.....	1SET	9PCS Air Knives.....	1SET
Air brush.....	1SET	Oil boxes.....	1SET
Small glass jar 22C.C...	4PCS		

● This Picture is just for reference, the actual contents depends on the items.

10SETS/CTN/3.3'





**FULL SET OF AB-116**

## **AB-116 AIR BRUSH KIT**

Double-action trigger Air-Paint control, special gun with fine round spray pattern, for art work, design & mural painting, fine regulation of material flow.

Contents:

1-Air brush, 2-10C.C. 5C.C. cup, 2-Adaptor, 1-wrench

Specification:

Fluid nozzle :0.2mm

Working pressure :15-30PSI

Air consumption : 0.4-0.8 CFM

Cup capacity : 10C.C. 5C.C.

Cup fix :Side screw fix

40SETS/CTN/1.9' NW:17.9KGS GW:18.9KGS



**FULL SET OF AB-119**

## **AB-119 AIR BRUSH KIT**

Double-action trigger Air-Paint control, Precisely machined fine nozzle, suitable for art work, design painting.

Contents:

1-Air brush, 2-22C.C. 50.C.C Glass jar,  
1-5' Air hose, 1-Adaptor, 1-Holder

Specification:

Fluid nozzle :0.3mm

Working pressure :15-30PSI

Cup capacity :22C.C. 50C.C.

Cup fix :detachable

40SETS/CTN/1.9' NW:18.3KGS GW:19.3KGS

## AB-120 AIR BRUSH KIT

Double-action trigger Air-Paint control, precisely machined nozzle, Suitable for art work, design painting.

Contents:

1-Air brush, 2-22C.C. 50C.C. Glass jar,  
1-5' Air hose, 1-Adaptor, 1-Holder

Specification:

Fluid nozzle :0.3mm

Working pressure :15-30PSI

Cup capacity :3C.C.

Cup fix :detachable

40SETS/CTN/1.9' NW:17.5KGS GW:18.5KGS



**FULL SET OF AB-120**

## AB-121 AIR BRUSH KIT

Double-action trigger Air-Paint control, Precisely machined fine nozzle, suitable for art work, design painting.

Contents:

1-Air brush, 2-22C.C. 50C.C. Glass jar,  
1-5' Air hose, 1-Adaptor, 1-Holder

Specification:

Fluid nozzle :0.3mm

Working pressure :15-30PSI

Cup capacity :2C.C.

Cap fix :detachable

40SETS/CTN/1.9' NW:17.5KGS GW:18.5KGS



FULL SET OF AB-121

**AB-122A/AB-122B**

**AIR BRUSH**

Double-action trigger Air-Paint control, Precisely machine fine nozzle, suitable for art work, design painting.

Specification:

Fluid nozzle :0.2mm

Working pressure :15-30PSI

Capacity of fixed cup :1.5C.C.

40SETS/CTN/1.9' NW:12.5KGS GW:13.5KGS

40SETS/CTN/1.3' NW:10.0KGS GW:11.0KGS

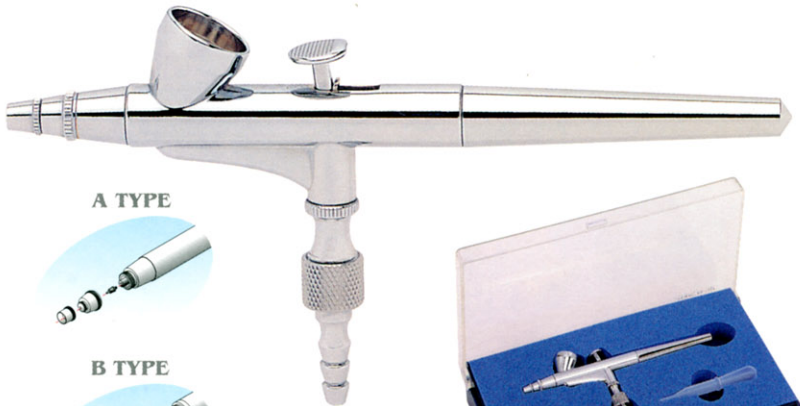

**A TYPE**

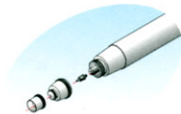

**B TYPE**

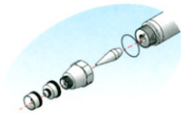

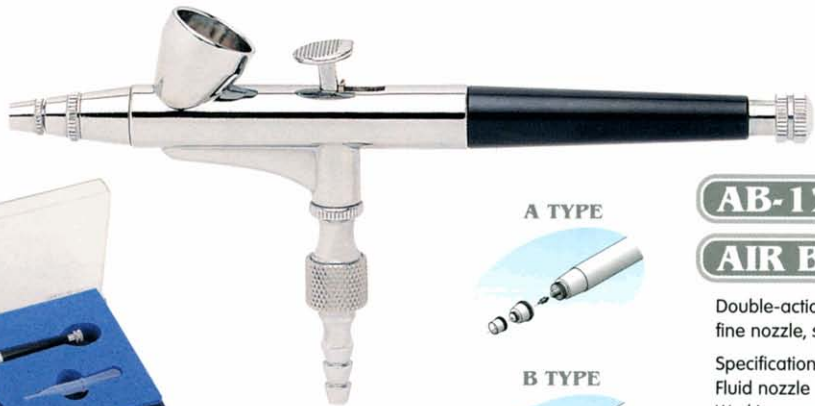

A TYPE



B TYPE



**AB-123A/AB-123B**

**AIR BRUSH**

Double-action trigger Air-Paint control, Precisely machine fine nozzle, suitable for art work, design painting.

Specification:

Fluid nozzle :0.2mm

Working pressure :15-30PSI

Capacity of fixed cup :1.5C.C.

Spray control :Back stop screw

40SETS/CTN/1.9' NW:12.5KGS GW:13.5KGS

40SETS/CTN/1.3' NW:10.0KGS GW:11.0KGS

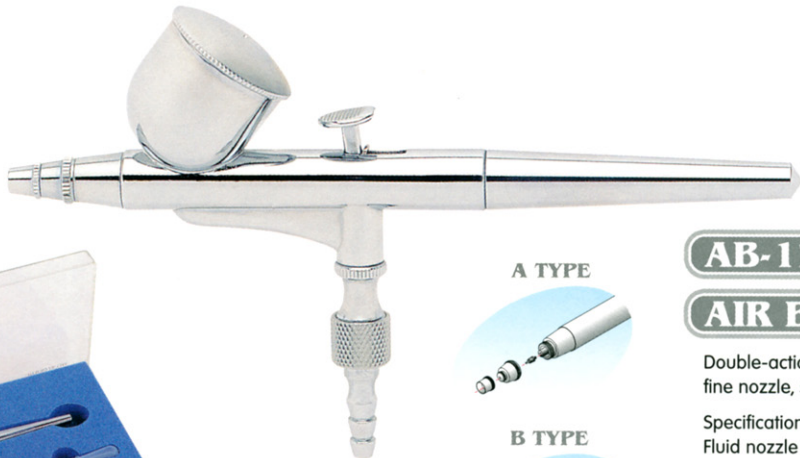

A TYPE

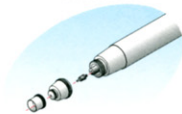

B TYPE

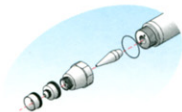

**AB-124A/AB-124B**

**AIR BRUSH**

Double-action trigger Air-Paint control, Precisely machine fine nozzle, suitable for art work, design painting.

Specification:

Fluid nozzle :0.3mm

Working pressure :15-30PSI

Capacity of fixed cup :5C.C.

40SETS/CTN/1.9' NW:13.5KGS GW:14.5KGS

40SETS/CTN/1.3' NW:11.2KGS GW:12.2KGS



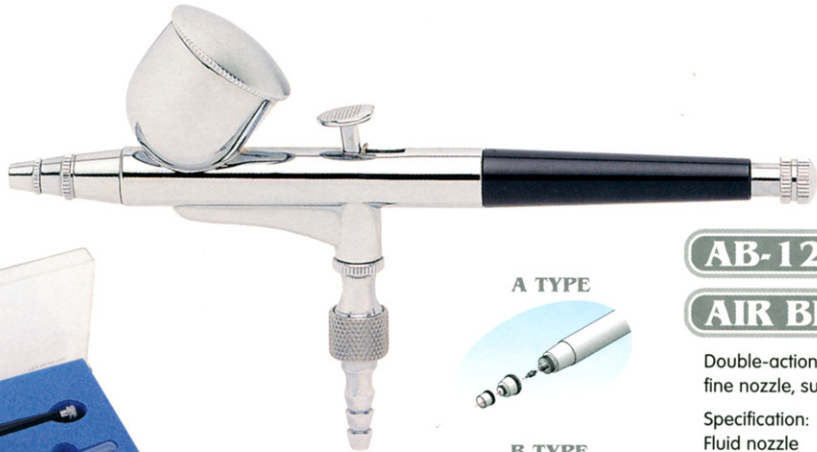

A TYPE

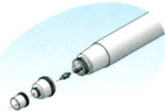

B TYPE

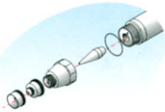

**AB-125A/AB-125B**

**AIR BRUSH**

Double-action trigger Air-Paint control, Precisely machine fine nozzle, suitable for art work, design painting.

Specification:

Fluid nozzle :0.3mm

Working pressure :15-30PSI

Capacity of fixed cup :5C.C.

Spray control :Back stop screw

40SETS/CTN/1.9' NW:13.5KGS GW:14.5KGS

40SETS/CTN/1.3' NW:11.2KGS GW:12.2KGS



**AB-126A/AB-126B**

**AIR BRUSH**

Double-action trigger Air-Paint control, Precisely machine fine nozzle, suitable for art work, design painting.

Specification:

Fluid nozzle :0.3mm  
Working pressure :15-30PSI  
Capacity of side screwed cup :5C.C.

40SETS/CTN/1.9' NW:13.5KGS GW:14.5KGS

40SETS/CTN/1.3' NW:11.2KGS GW:12.2KGS



**A TYPE**

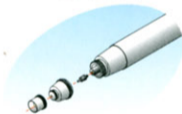

**B TYPE**

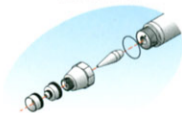

**AB-127A/AB-127B**

**AIR BRUSH**

Double-action trigger Air-Paint control, Precisely machine fine nozzle, suitable for art work, design painting.

Specification:

Fluid nozzle :0.3mm

Working pressure :15-30PSI

Capacity of side screwed cup :5C.C.

Spray control :Back stop screw

40SETS/CTN/1.9' NW:13.5KGS GW:14.5KGS

40SETS/CTN/1.3' NW:11.2KGS GW:12.2KGS



**A TYPE**

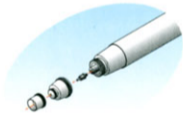

**B TYPE**

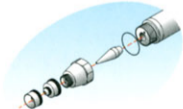

## AB-128A AIR BRUSH

Double-action trigger Air-Paint control, Precisely machine fine nozzle, suitable for art work, design painting.

Specification:

Fluid nozzle :0.2mm

Working pressure :15-30PSI

Capacity for pigment :0.4C.C.

40SETS/CTN/1.9' NW:12.0KGS GW:13.0KGS

40SETS/CTN/1.3' NW:9.4KGS GW:10.4KGS





## AB-129A AIR BRUSH

Double-action trigger Air-Paint control, Precisely machine fine nozzle, suitable for art work, design painting.

Specification:

Fluid nozzle :0.2mm

Working pressure :15-30PSI

Capacity for pigment :0.4C.C.

Spray control :Back stop screw

40SETS/CTN/1.9' NW:12.0KGS GW:13.0KGS

40SETS/CTN/1.3' NW:9.4KGS GW:10.4KGS



**A TYPE**

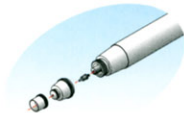

**B TYPE**

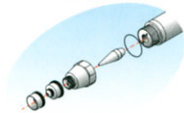

**AB-130A/AB-130B**

**AIR BRUSH**

Double-action trigger Air-Paint control, Precisely machine fine nozzle, suitable for art work, design painting.

Specification:

Fluid nozzle :0.3mm

Working pressure :15-30PSI

Capacity for pigment :22C.C.

40SETS/CTN/1.9' NW:13.5KGS GW:14.5KGS

40SETS/CTN/1.3' NW:11.2KGS GW:12.2KGS

**AB-130BS/AB-131BS**

**DOUBLE ACTION AIR BRUSH KIT**

**FULL SET OF ABI30B-ABI31B**

Double-action trigger Air-Paint control, internal mix. Precision ultra-fine needle and nozzle, suitable for art work and fine detail painting. Working Pressure:15-30PSI

Contents:

- Air brush.....1PC
- Jar Adaptor.....1PC
- Brushed Hose.....1PC
- Jar.....3PCS (22C.C.x2, 50C.C.)
- Paint Cup.....1PC (5C.C.)
- Wrech.....1PC
- Needles.....2PC (0.5mm, 0.7mm)
- Nozzles.....2PC (0.5mm, 0.7mm)

● This Picture is just for reference, the actual contents depends on the items.

20SETS/CTN/3' NW:113.5KGS GW:14.5KGS





A TYPE



B TYPE

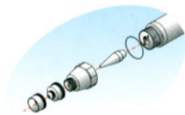

**AB-131A/AB-131B**

**AIR BRUSH**

Double-action trigger Air-Paint control, Precisely machine fine nozzle, suitable for art work, design painting. Minor adjustment tail is available.

Specification:

Fluid nozzle : AB-131A: 0.3mm  
AB-131B: 0.5mm

Working pressure :15-30PSI

Capacity for pigment :90C.C.

40SETS/CTN/1.9' NW:13.5KGS GW:14.5KGS

40SETS/CTN/1.3' NW:11.2KGS GW:12.2KGS

## AB-132A/AB-132B

### AIR BRUSH

Double-action trigger Air-Paint control, Precisely machine fine nozzle, suitable for art work, design painting.

Specification:

Fluid nozzle : AB-132A: 0.3mm

AB-132B: 0.5mm

Working pressure :15-30PSI

Capacity for pigment :90C.C.

40SETS/CTN/1.9' NW:13.5KGS GW:14.5KGS

40SETS/CTN/1.3' NW:11.2KGS GW:12.2KGS

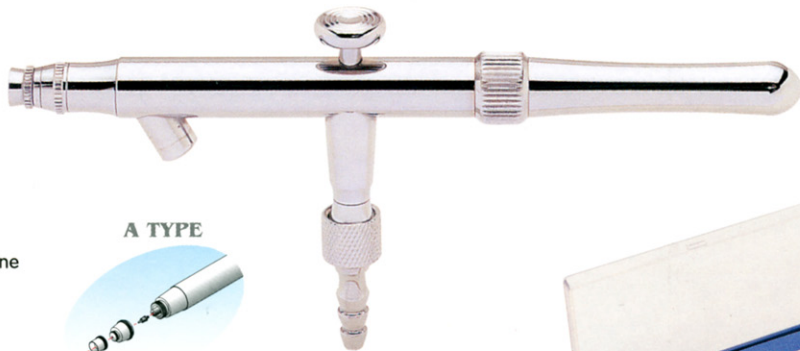

A TYPE

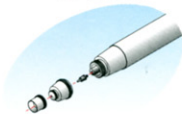

B TYPE

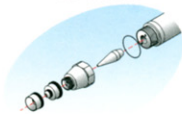





A TYPE

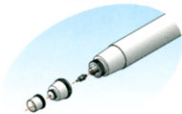

B TYPE

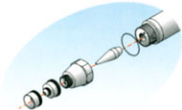

**AB-133AL/AB-133BL**

**AIR BRUSH**

Double-action trigger Air-Paint control, Precisely machine fine nozzle, suitable for art work, design painting.

Specification:

Fluid nozzle :0.3mm

Working pressure :15-30PSI

Capacity of fixed cup :13C.C.

40SETS/CTN/1.9' NW:13.5KGS GW:14.5KGS

40SETS/CTN/1.3' NW:11.2KGS GW:12.2KGS



**AB-133AM/AB-133BM**

**AIR BRUSH**

Double-action trigger Air-Paint control, Precisely machine fine nozzle, suitable for art work, design painting.

Specification:

Fluid nozzle :0.3mm

Working pressure :15-30PSI

Capacity of fixed cup :5C.C.

40SETS/CTN/1.9' NW:13.5KGS GW:14.5KGS

40SETS/CTN/1.3' NW:11.2KGS GW:12.2KGS

**A TYPE**

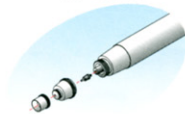

**B TYPE**

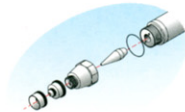

## AB-133AS/AB-133BS

### AIR BRUSH

Double-action trigger Air-Paint control, Precisely machine fine nozzle, suitable for art work, design painting.

Specification:

Fluid nozzle :0.3mm

Working pressure :15-30PSI

Capacity of fixed cup :2C.C.

40SETS/CTN/1.9' NW:13.5KGS GW:14.5KGS

40SETS/CTN/1.3' NW:11.2KGS GW:12.2KGS

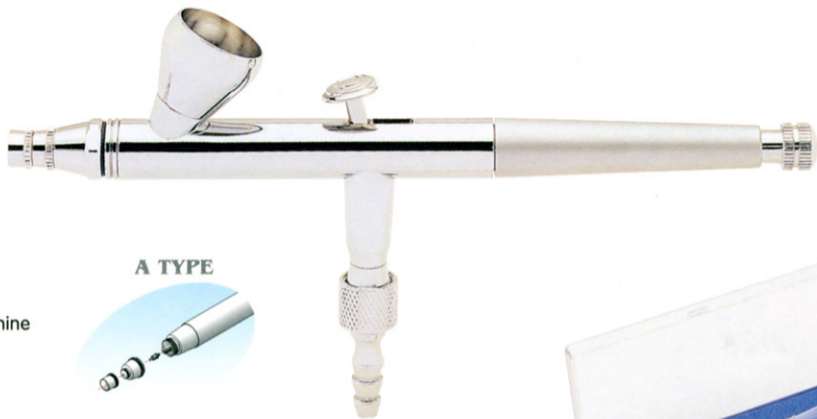

A TYPE

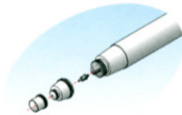

B TYPE

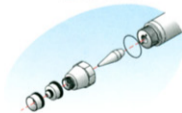

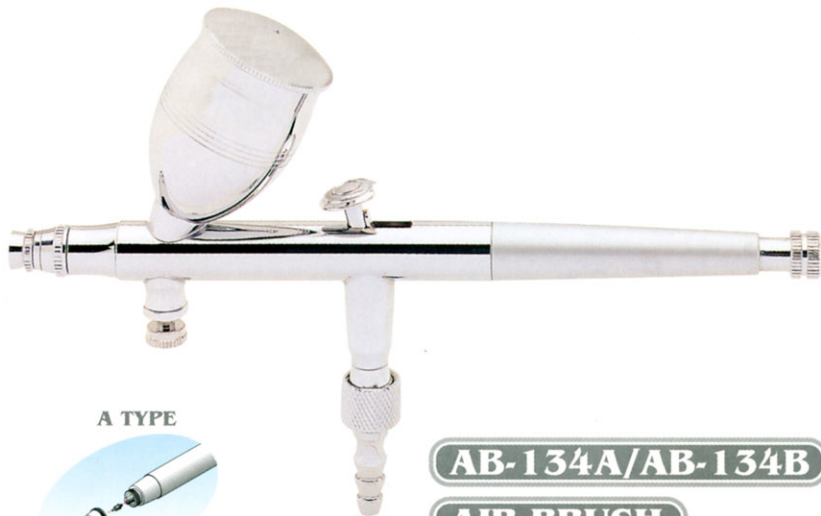

**A TYPE**

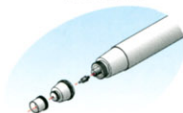

**B TYPE**



**AB-134A/AB-134B**

**AIR BRUSH**

Double-action trigger Air-Paint control, Precisely machine fine nozzle, suitable for art work, design painting.

Specification:

Fluid nozzle :0.3mm

Working pressure :15-30PSI

Capacity of cup :2C.C. 5C.C. 13C.C.

40SETS/CTN/1.9' NW:13.5KGS GW:14.5KGS

40SETS/CTN/1.3' NW:11.2KGS GW:12.2KGS



## AC-101 AIR BRUSH CABIN

Simply design spray cabin prevent the paint from dispersing, and the surrounding airflow won't influence the painting work. The paint then can be distributed evenly on the object.

Size:55cmX36cmX18cm (LXBXH)

CE



CP-101A



CP-101

**CP-101A**

**CP-101**

Electric motor :1/8HP 110V/220V, 60/50Hz  
:110V/60Hz, 0.90CFM(25L/min)  
Air displacement :220V/50Hz, 0.75CFM(21L/min)  
Connection :1/8"  
Max. pressure :50PSI (3.5kgs)  
Electric cable :1.5M  
Weight :4.3kgs  
RPM :110V/1700, 220V/1400  
AMP :110V/1A, 220V/0.5A

CP-101 4PCS/CTN/1.4' NW:17.0KGS GW:18.0KGS

CP-101A 4PCS/CTN/1.4' NW:18.4KGS GW:19.4KGS



## CP-102

Electric motor	:1/8HP 110V/220V, 60/50Hz
Air displacement	:110V/60Hz, 0.90CFM(25L/min) :220V/50Hz, 0.75CFM(21L/min)
Connection	:1/8"
Max. pressure	:50PSI (3.5kgs)
Electric cable	:1.5M
Weight	:7.5kgs
RPM	:110V/1700, 220V/1400, 240V/1400
AMP	:110V/1A, 220V/0.5A
Tank size	:30cmx12.5cmx12.5cm
Tank capacity	:3,500C.C.
2PCS/CTN/2.0' NW:16.0KGS GW:17.0KGS	



## CP-103

Electric motor :1/8HP 110/220V, 60/50Hz  
Air displacement :110V/60Hz, 0.90CFM(25L/min)  
:220V/50Hz, 0.75CFM(21L/min)  
Connection :1/8"  
Max. pressure :38PSI (2.8kgs)  
Electric cable :1.5M  
Weight :7.7kgs  
RPM :110V/1700, 220V/1400. 240V/1400  
AMP :110V/1A, 220V/0.5A  
Tank size :30cmx12.5cmx12.5cm  
Tank capacity :3,500C.C.  
Air pressure auto switch

2PCS/CTN/2.0' NW:16.5KGS GW:17.5KGS



CE



CP-201



CP-201A



CP-201AB



CP-201B

### CP-201

Electric motor :1/6HP 110/220V, 60/50Hz  
Air displacement :110V/60Hz 1.8CFM (50.4L/min)  
:220V/50Hz 1.5CFM (42L/min)  
Connection :1/8"  
Max. pressure :60PSI (4.2kgs)  
Electric cable :1.5M  
Weight :4.3kgs  
RPM :110V/3400, 220V/2800  
AMP :110V/1.6A, 220V/0.8A

4PCS/CTN/1.4' NW:21.0KGS GW:22.0KGS



## CP-202

Electric motor	:1/6HP 110/220V,60/50Hz
Air displacement	:110V/60Hz 1.8CFM (50.4L/min) :220V/50Hz 1.5CFM (42L/min)
Connection	:1/8"
Max. pressure	:60PSI (4.2kgs)
Electric cable	:1.5M
Weight	:7.7kgs
RPM	:110V/3400, 220V/2800, 240V/2800
AMP	:110V/1.6A, 220V/0.8A
Tank size	:30cmx12.5cmx12.5cm
Tank capacity	:3,500C.C.

2PCS/CTN/2' NW:18.0KGS GW:19.0KGS



## CP-203

Electric motor	:1/6HP 110/220V, 60/50Hz :110V/60Hz 1.8CFM (50.4L/min)
Air displacement	:220V/50Hz 1.5CFM (42L/min)
Connection	:1/8"
Max. pressure	:60PSI (4.2kgs)
Electric cable	:1.5M
Weight	:7.7kgs
RPM	:110V/3400, 220V/2800, 240V/2800
AMP	:110V/1.6A, 220V/0.8A
Tank size	:30cmx12.5cmx12.5cm
Tank capacity	:3,500C.C.
Air pressure auto switch	

2PCS/CTN/2' NW:18.5KGS GW:19.5KGS



### DP-01

Max. output :1500 Liters/hour  
Max. pumping height :15M  
Max. selfpriming :To 300cm  
Max. outlet pressure :3 bar  
Inlet/outle coupling :3/8"  
60PCS/CTN/3.4' NW:11.0KGS GW:12.1KGS



### DP-02

60PCS/CTN/3.4' NW:15.2KGS GW:16.3KGS

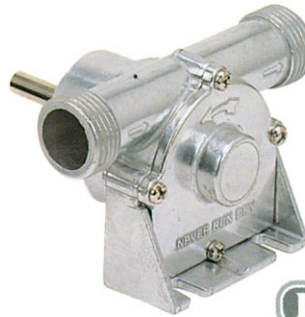

### DP-06

24PCS/CTN/1.6' NW:9.0KGS GW:10.0KGS



### DP-03

Max. output :3000 Liters/hour  
Max. pumping height :20M  
Max. selfpriming :To 400cm  
Max. outlet pressure :3 bar  
Inlet/outle coupling :3/4"  
40SETS/CTN/2.2' NW:14.0KGS GW:15.0KGS

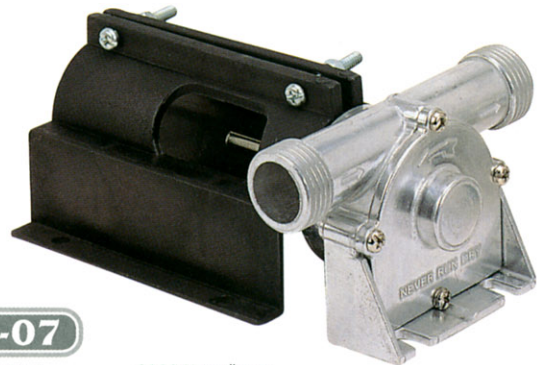

### DP-07

Max. output :3000 Liters/hour  
Max. pumping height :20M  
Max. selfpriming :To 400cm  
Max. outlet pressure :3 bar  
Inlet/outle coupling :3/4"  
40SETS/CTN/2.8' NW:18.2KGS GW:19.5KGS

# Drill Pump SELF-PRIMING

Ideal for pumping out garden ponds, rain-water barrels, flooded cellars, aquariums irrigating of field and garden. Also for decanting of barrels which contain heating diesel, lye and wine. Selfpriming and for permanent working, Suitable for all power drill.



max.  
**3000l/h**



**3/4"**

**3/4"**  
+  
**1/2"**

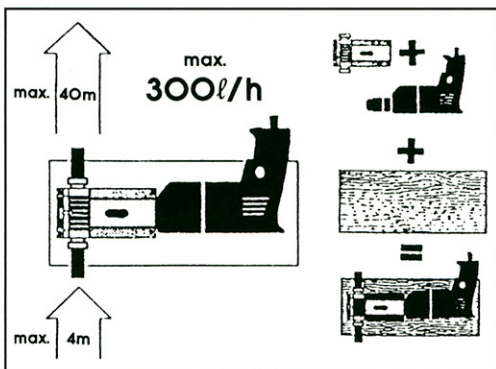
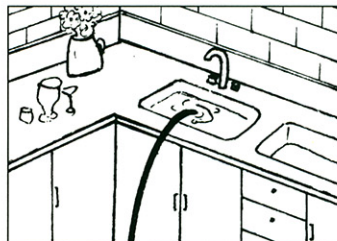
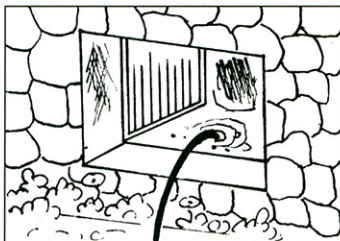
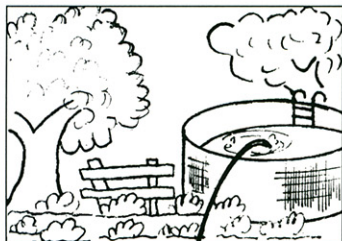

## HD-01 DELUXE AIR BRUSH HOLDER

The HOLDER will bring much convenience on using air brush. The well designed stands are good for holding all Air Brush and Filler/Regulator.

PAT.NO.67554

36PCS/CTN/3.3' NW:15.9KGS GW:17.2KGS



**SPE-04**

20PCS/CTN/1.2' NW:10.0KGS GW:11.0KGS

## ***BUSHING REMOVING & INSERTING SET***

**This set consists of the following components:**



No.	Description	Small Diameter	Large Diameter	No.	Description	Small Diameter	Large Diameter
B-1	Bushing Adoptor	3/8"	7/16"	B-11	Bushing Adoptor	15/16"	1-1/16"
B-2	Bushing Adoptor	7/16"	1/2"	B-12	Bushing Adoptor	1"	1-1/8"
B-3	Bushing Adoptor	1/2"	9/16"	B-13	Bushing Adoptor	1-1/16"	1-3/16"
B-4	Bushing Adoptor	9/16"	5/8"	B-14	Bushing Adoptor	1-1/8"	1-1/4"
B-5	Bushing Adopto	{ 39/64" 5/8"	{ 43/64" 11/16"	B-15	Bushing Adoptor	1-3/16"	1-5/16"
B-6	Bushing Adoptor	5/8"	3/4"	B-16	Bushing Adoptor	1-1/4"	1-3/8"
B-7	Bushing Adoptor	11/16"	13/16"	D-1	Driver (Small)	-	-
B-8	Bushing Adopto	{ 47/64" 3/4"	{ 55/64" 7/8"	D-2	Driver (Medium)	-	-
B-9	Bushing Adoptor	13/16"	15/16"	D-3	Driver (Large)	-	-
B-10	Bushing Adopto	{ 55/64" 7/8"	{ 63/64" 1"	N-1	Nut for & D2 Driver	-	-
				N-2	Nut for D3 Driver	-	-

15SETS/CTN/0.8' NW:21.0KGS GW:22.0KGS



## *Low-High* SPRAY GUN

### SG-215 HIGH PRESSURE SPRAY GUN

Handy fine atomization paint gun, Stainless steel  
needle, With Air, Fan and Paint regulator

Specification:

Fluid nozzle	:0.8mm
Working pressure	:40-70PSI
Air consumption	:1.6-4.0 CFM
Cup Capacity	:150C.C

20SETS/CTN/2' NW:11.0KGS GW:12.0KGS



# *SPECIFICATION FOR SPARE PARTS LIST*



**SPA-01**

AIR HOSE ADAPTOR  
M5x0.45, 1/4"x19



**SPA-02**

TIRE ADAPTOR



**SPA-03**

AIR HOSE ADAPTOR M5x0.45



**SPA-04**

1/8" AIR HOSE ADAPTOR



**SPA-05**

ADAPTOR M5x0.45-1/8"



**SPA-06**

ADAPTOR 1/8"x1/8"



**SPA-07**

ADAPTOR 1/8"x1/4"



**SPA-08**

1/8" QUICK RELEASE  
ADAPTOR



**SPA-09**

QUICK RELEASE  
ADAPTOR M5x0.45



**SPA-10**

PRESSURE REGULATOR  
1/8"-1/8"



**SPB-01**

WRENCH

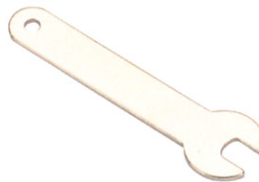

**SPB-02**

WRENCH

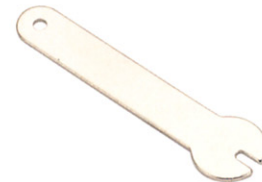

**SPB-03**

WRENCH



**SPC-01**  
BIG GLASS JAR 50C.C.



**SPC-02**  
SMALL GLASS JAR 22C.C



**SPC-03**  
CLEANER



**SPC-04**  
22C.C. CUP



**SPC-05**  
3C.C. CUP



**SPC-06**  
2C.C. CUP



**SPC-07**  
5C.C. CUP



**SPD-01**  
AIR HOSE SET M5x0.45, 5FT.



**SPD-02**  
AIR HOSE  
SET 10FT 1/8"-1/4"



**SPD-03**  
AIR HOSE SET 6.5FT 1/8"-1/4"



**SPD-04**  
AIR HOSE SET  
6.5FT 1/8"-1/8"



**SPD-05**  
AIR HOSE SET  
6.5FT 1/8"-1/4"



**SPD-06**  
AIR HOSE SET  
6.5FT 1/8"-1/8"



**SPD-07**  
AIR HOSE SET  
6.5FT 1/8"-M5x0.45



**SPE-01**  
PROPEL CAN REGULATOR



**SPE-02**  
OIL BOXES



**SPE-03**  
AIR BRUSH HOLDER



**SPE-04**  
MINI FIL/REGULATOR

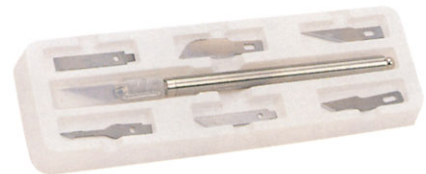

**SPE-05**  
9PCS AIR KNIVES

# Tire Repair Kit



- 1-Repair Gun
- 1-Drill
- 1-Lubricant
- 1-Scissor
- 1-Adaptors
- 50-Rubber plugs

20SETS/CTN/1.5' NW:16.0KGS GW:17.0KGS

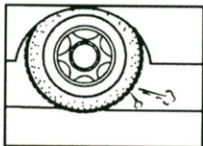

1. Find out the nail on tire

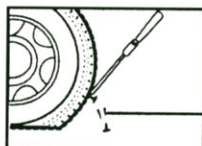

2. Remove the nail from the tire with a drill

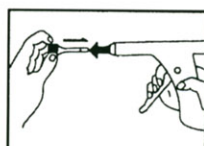

3. Put rubber plug with lubricant into the gun.

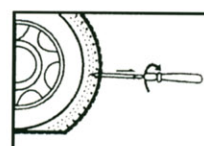

4. Screw adaptor to drill and use drill with lubricant to push adaptor into tire through the damaged hold. Leave the adaptor and screw out the drill.

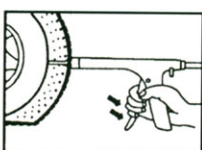

6. Pull the trigger gradually until the rubber plug being pushed into the tire through defective parts.

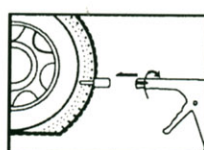

5. Screw gun head tightly to the adaptor.

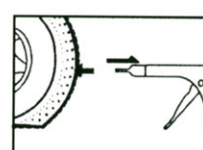

7. Pull gun out off tire.

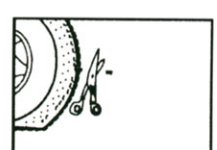

8. Cut off rubber tail by using the scissors.

